

**ADVANCED
TURF SOLUTIONS®**

**J&D
TURF®**

Sports Field Resource Guide





ADVANCED TURF SOLUTIONS | J&D TURF

Advanced Turf Solutions and J&D Turf are your full-service partners for creating safe, playable, and aesthetically pleasing natural grass and other athletic surfaces for athletes of all ages and abilities. Advanced Turf Solutions is an independent, employee-owned distributor offering an extensive portfolio of quality sports field products. Our service division, J&D Turf, offers sports turf consulting, construction, and maintenance to help you get the job done on time and on budget. The combined organization shares a deep commitment to providing service that is second to none.

Our team of experts, including former professional head groundskeepers and a former professional baseball player, can provide a wealth of knowledge with more than 100 years of combined experience in the areas of athletic field and turf maintenance, construction and design.

Our clients range from MLB, NFL, NCAA, school corporations, and recreational athletic fields. Our services include one-to-one consultation, field evaluation and scientific field analysis, project design, construction, installation, and instructional services for field maintenance and upkeep.

Whether you're Major League or Little League, we have the knowledge, experience, and products to help you provide the best playing field surfaces to fit your budget.

Smart.

Providing the best value and quality sports field products for your long-lasting investment.

Service.









Nineteen locations to serve you better. Offering to-your-door forklift delivery.

Solutions.

Experts to assist you in solving your toughest sports field problems.



TABLE OF CONTENTS

	CONDITIONERS & CLAY	4
	FIELD MARKING	8
	MAINTENANCE TOOLS & FIELD ACCESSORIES	10
	EQUIPMENT	16
	GRASS SEED	18
	FERTILIZER & CHEMICALS	21
	SERVICE	25
	FIELD DIMENSIONS	27

CONDITIONERS & CLAY

Infield Conditioners

Pro's Choice® Red



PRODUCT DESCRIPTION: Designed to meet the challenges of wet, dry or compacted infields, this unique durable granule helps create passageways for drainage and eliminate compaction for truer bounces and safer play. Granule size: 5 x 20.
PACKAGE SIZES: 50 lb. bag, 40 bags/pallet

Pro's Choice® Pro Red



PRODUCT DESCRIPTION: This premium topdressing is the only deep red conditioner that maintains its rich color. Used by professional groundskeepers to achieve a championship look and formulated for uniform particle size and durability. Granule size: 8 x 16.
PACKAGE SIZES: 50 lb. bag, 40 bags/pallet

Pro's Choice® Select



PRODUCT DESCRIPTION: This premium infield conditioner keeps infields smooth, safe and resilient. Its specially sized granules and red color makes the perfect infield topdressing. Granule size: 8 x 16.
PACKAGE SIZES: 50 lb. bag, 40 bags/pallet

Pro's Choice® Rapid Dry



PRODUCT DESCRIPTION: Stay in the game with Rapid Dry drying agent. These tiny granules are designed to quickly wick away excess water from your infield and keep your games playing safely and without delay. Granule size: 16 x 80.
PACKAGE SIZES: 50 lb. bag, 40 bags/pallet

SAF 516 Conditioner



PRODUCT DESCRIPTION: Calcined clay field conditioner. Screened at 5/16 mesh size.
PACKAGE SIZES: 50 lb. bag

SAF 816 Conditioner



PRODUCT DESCRIPTION: Calcined clay field conditioner. Screened at 8/20 mesh size.
PACKAGE SIZES: 50 lb. bag

SAF Sure Dry



PRODUCT DESCRIPTION: Calcined clay product designed to quickly remove excess water from your skinned areas.
PACKAGE SIZES: 50 lb. bag

In-Flow™ Infield Skin Maintenance



PRODUCT DESCRIPTION: In-Flow™ is a granular soil conditioner and surfactant that influences water's ability to flow into and throughout the profile of infield skins. This helps sports turf managers find the desired balance between water retention and movement, resulting in a better performing infield over a longer period of time.
PACKAGE SIZES: 50 lb. bag



Mound Repair

1. Excavate the front slope of your mound to a 4-6 inch depth. Batter's boxes and catcher's box to a 4 inch depth.
2. Moisten the bottom of the hole with water. Add an inch of mound clay with a rake; cut into the soil for proper bonding. Tamp firmly. Lightly moisten but do not drown, and tamp again.
3. Evenly add an inch of new mound clay to the area you are working. Tamp until firm. Water the area, but do not drown. Repeat. As you near the last layer, reduce the amount of water you add to the mound clay.
4. Use a rake to rough grade the slope in front of the mound. Tamp or roll the slope for a smooth surface. Add mound clay to any low spots and use your rake to cut down the high spots. After leveling, tamp or roll again.
5. Add a final coating of water on the mound clay areas once all grades and slopes are set and rolled. Finally, topdress all mound clay areas with infield conditioner to match the color of your infield.
6. Moisture management is key to keeping holes to a minimum. The use of rubber mats and/or a mound tarp are recommended after play is finished.



2 0

3 0

4 0

CONDITIONERS & CLAY



Mound Clay

SAF 5-Star Packing Clay



PRODUCT DESCRIPTION:
Calcined clay field conditioner.
Screened at 8/20 mesh size.
PACKAGE SIZES: 50 lb. bag

Pro's Choice® Pro Mound Packing Clay



PRODUCT DESCRIPTION:
A unique blue gumbo packing clay, Pro Mound bonds to form a solid subsurface that allows players to "dig in" and establish footing without leaving large holes. Also available in pre-formed bricks.
PACKAGE SIZES: 50 lb. bag, 40 bags/pallet, 312 bricks/pallet



FROM THE **SMART TURF** BLOG

SMART TURF TIP

Batter's Box Repair

1. Excavate the batter's box 3 inches deep.
2. Install the mound clay and tamp in. Soak area after tamp and let set for 20 minutes.
3. Spread a thin layer of infield mix over new clay.
4. Topdress with conditioner to match the color of your infield.
5. Moisture management is key to keeping holes to a minimum. The use of rubber mats or a plate tarp are recommended after play is finished.



SMART TURF TIP

FROM THE SMART TURF BLOG



Smart START Program

- S**—Site Visit
- T**—Testing
- A**—Analysis
- R**—Recommendations
- T**—Training

Smart START is the concept of using science-based testing to make the most accurate recommendations for your athletic fields in the industry. By using multiple methods and scientific tools to gather data, we can maximize your budgetary dollars and target the specific areas of need. These recommendations are then used to create the best experience on your athletic fields for the players, coaches, athletic directors, grounds keepers, and the fans. Smart START provides a safe and predicable playing surface that is easier to manage and is aesthetically pleasing to all. Talk to your Advanced Turf Solutions representative about a free field evaluation and get your facility enrolled in the Smart START Program.

Benefits include:

- An ATS Virtual Groundskeeper
- State of the Art Technology
- Bundle Pricing Discounts
- Free Educational Seminars
- Staff Training

Infield Mix Evaluation

Our infield mix evaluation involves taking a sample from your infield, testing the mix at a laboratory, running soil texture analysis to determine the sand/silt/clay ratio, and making amendment recommendations based on laboratory analysis.

Comprehensive Soil Testing with Soil Solver

Diagnose nutrient deficiencies, optimize nutrient applications, and develop the right course of action for your turf's specific needs through comprehensive soil testing.

Soil Solver reports show the total nutrients and the nutrients immediately available to the plant in the soil with recommendation metrics that are based on thousands of soil tests from a variety of growing environments. This data allows us to customize a product mix based on the actual needs and reduce unnecessary inputs while improving application efficiency—maximizing the health and performance of your sports turf.

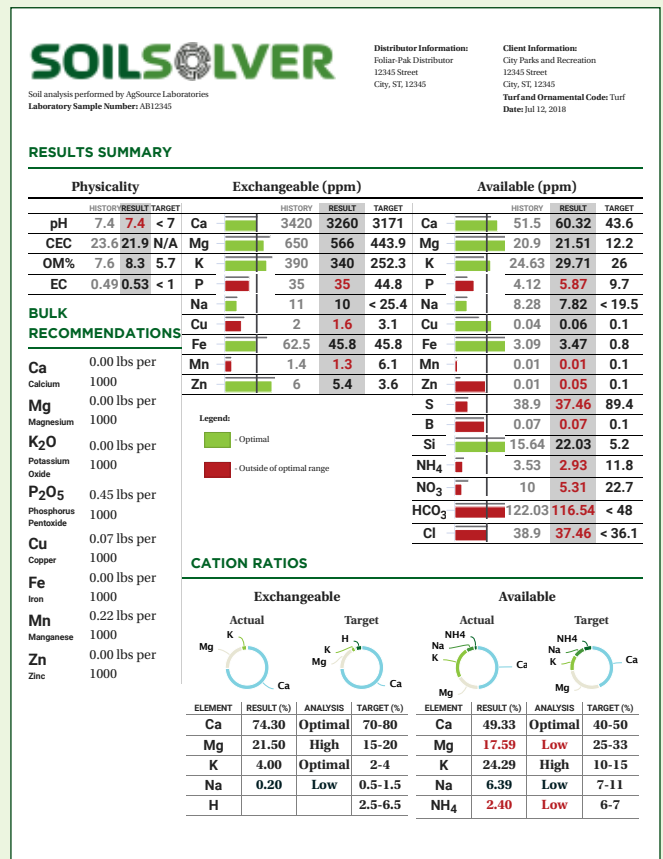

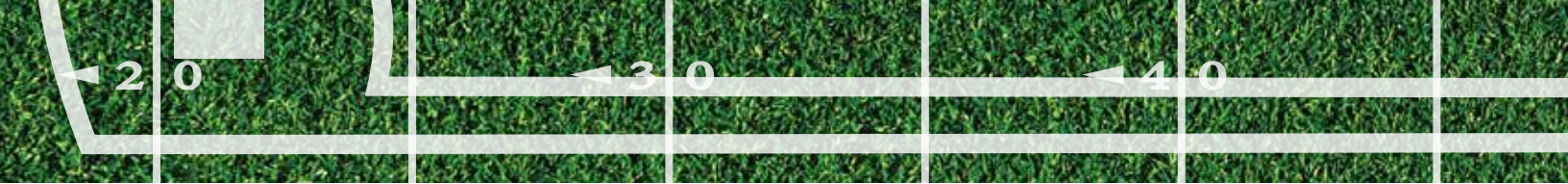

FIELD MARKING

Equipment



iGO Deluxe

PRODUCT DESCRIPTION: The next generation spray marking machine for a range of playing and recreational surfaces, both natural and synthetic. The iGO is developed for grounds staff by grounds staff who want the best equipment for line marking. The machine is easy to set up, operate, and clean after use. All iGOs come with a simple on-off power button that gives the operator full control, a heavy-duty pump that ensures constant pressure, a rechargeable battery that can be charged on the machine or removed and charged off site, marker discs, and a variety of unique cone nozzles.



iGO Mini

PRODUCT DESCRIPTION: A superb line marker for clubs and schools with a small number of sports fields. The iGO Mini has similar features to the iGO Deluxe and is smaller.

Accessories

Flush Thru for iGO



PRODUCT DESCRIPTION: Flush Thru is a specially formulated ready-to-use cleaner for use with the iGO Deluxe, iGO Mini and other spray machines. It is ideal for regular cleaning maintenance, preventing accumulation of paint residues in piping, filters, pumps and nozzles.
PACKAGE SIZES: 10 liter (2.64 gallons) canister

Green Out



PRODUCT DESCRIPTION: Specially formulated to cover applied markings on grass to allow for change of playing use, where the change needs to be made quickly. The color has been specifically mixed to blend in with the majority of grass types and dries quickly to allow over-painting with the minimum of delay.
PACKAGE SIZES: 10 liter (2.64 gallons) canister



FIELD MARKING

Chalk

Line Marking Chalk

PRODUCT DESCRIPTION: Made from calcium carbonate, line marking chalk is safe for players, equipment and turf. For quantity needed, follow this simple rule of thumb: one 50 lb. bag of chalk will stripe approximately 300' L x 2" at x 1/16" D line.
PACKAGE SIZES: 50 lb. bag

Paint



Impact XP



PRODUCT DESCRIPTION: Environmentally friendly, ready to use paint with no mixing required for playing fields and sports courts. The paint is developed for the iGO machines and can be applied with cone as well as flat fan nozzles. It allows you to over-mark a standard sized football pitch from as little as one liter of paint. The XP is the brightest and longest lasting of the Impact line. White color only.
PACKAGE SIZES: 10 liter (2.64 gallons) canister, 5 liter (1.32 gallon) eco-bag



Impact

PRODUCT DESCRIPTION: With excellent color and durability, the regular Impact, ready to use paint balances quality and economics. As with Impact XP, the Impact paint can cover a standard sized football pitch from as little as one liter of paint. Colors include white, yellow, blue, red, orange, and black.
PACKAGE SIZES: 10 liter (2.64 gallons) canister



FROM THE **SMART TURF** BLOG

SMART TURF TIP

"When line marking machines are used in hot weather conditions or where there is an interval of more than 15 minutes between marking different sites, it is advisable to remove the nozzle as soon as possible after marking/stripping to avoid paint drying on the nozzle. For this, plain water will keep the nozzle in good condition. Always carry some spare nozzles to avoid costly delays."

—Joby Morrow, Equipment Manager **ADVANCED TURF SOLUTIONS**

MAINTENANCE TOOLS & FIELD ACCESSORIES

Soccer Goals, Nets, & Corner Flags

Soccer Goals and Nets

PRODUCT DESCRIPTION: Offering nets and a variety of soccer goals including training goals, infinity pop-up goals, Futsal, full-size goals, and goals in various sizes. Kwik Goal products range from backyard use to games played on the world stage. Take your game to the next level with Kwik Goal.



Corner Flags

PRODUCT DESCRIPTION: Kwik Goal corner flags are available for natural and artificial surfaces.



Tarps

Mound, Plate, & Infield Tarps

PRODUCT DESCRIPTION: Prevents rain events from saturating clay. Allows for existing clay moisture to be retained; 14 or 18 oz vinyl; 14 different colors and custom sizes available. Standard sizes and colors available.



Turf Covers

PRODUCT DESCRIPTION: Turf covers retain natural heat and moisture that speed up seed germination and promote deep root development. In colder climates, turf greens up earlier in the spring. Field tarps are also great to do quick turf repairs, and because of its light weight, even large size covers are easily handled.



Fence Cap, Padding, & Windscreens

Fence Cap

PRODUCT DESCRIPTION: Adds safety and enhancement to any field. UV treated polyethylene to last for years. Available in yellow, forest green, and black. Available in 2 roll lengths: 100' or 250'. Each roll has 4.5" diameter. Limited 2-year warranty.



Windscreens

PRODUCT DESCRIPTION: Tough, high quality windscreens made with a super-durable mesh fabric of tightly woven microfibers and finished with double-needle lock stitching. It is virtually tear-proof. Available in 20 colors and with custom multi-color imprinting. Grommets installed every 12". 78% shading.

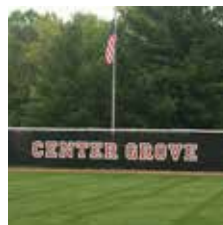

MAINTENANCE TOOLS & FIELD ACCESSORIES

Bases, Pitching Rubbers & Home Plates

Bases



PRODUCT DESCRIPTION: Jack Corbett MLB Hollywood Base, proudly made by Schutt Sports, remains the official base of Major League Baseball and is used on every MLB field.

- Extended, tapered lip virtually eliminates edge turn up
- Engineered to better withstand bad weather and also includes special ultraviolet inhibitors
- Added tensile strength to prevent most cuts and tears
- Comes with 6" stanchion
- Ground plugs and anchors sold separately

Item# SS-12902010

Home Plate



PRODUCT DESCRIPTION: Hollywood Bury-All Home Plate. Maximum strength, all rubber construction with no spikes needed for installation. Non-skid rubber surface. Ideal for permanent installation.

Item# SS-12807100

Pitching Rubber



PRODUCT DESCRIPTION: Schutt official 4-sided Hollywood style professional pitching rubber. Constructed of rubber and internal PVC tube. 6 x 24"

Item# SS-12909180

Backstop Netting & Batting Cage

Backstop Netting

PRODUCT DESCRIPTION: Custom design netting systems provide a quality, heavy duty product that can withstand rugged play and unpredictable weather.



Batting Cage

PRODUCT DESCRIPTION: Durable powder coated poles allow for a cable design with limited poles. Available in custom sizes.



MAINTENANCE TOOLS & FIELD ACCESSORIES

Shovels



Round Point Shovel

PRODUCT DESCRIPTION:
14 gauge #2 round point front turn step shovel with 48" solid core fiberglass handle.

Item# CC-SS60020



Square Point Shovel

PRODUCT DESCRIPTION:
Black 14 gauge #2 head with forward turned step. 48" solid core fiberglass handle.

Item# CC-SS61020



Scoop Shovel

PRODUCT DESCRIPTION:
Poly grain scoop with 29" yellow fiberglass handle and poly D-grip.

Item# SMW- 49253



Dig Out Tool

PRODUCT DESCRIPTION:
Clean and remove dirt from your base ground anchors with the Dig Out Tool. Constructed with a steel blade and tough wooden handle.

Tamps



Tamp

PRODUCT DESCRIPTION: 8" x 8" tamp with cast iron head and 44" hardwood handle.

Item# SMW-85088

SMART TURF TIP

FROM THE **SMART TURF** BLOG



Having proper tools to make the final grooming touches is important on all levels of sports turf. Not sure what you need? Let us help you find the right tools for the job.

MAINTENANCE TOOLS & FIELD ACCESSORIES

Rakes



Field Rake

PRODUCT DESCRIPTION:
36" field/ aggregate rake with 66" blue aluminium powder coated handle. Turn over for an extra-long smoothing edge.

Item# SMW-10036



Double Play Rake

PRODUCT DESCRIPTION:
36" double play/ dual purpose rake with 66" blue aluminium handle.

Item# SMW-12536



Leaf Rake

PRODUCT DESCRIPTION:
26-tine leaf rake with 24" poly head, 51" yellow fiberglass handle, cushion grip.

Item# SMW-40872



Rollers



Non-Absorbant Roller Squeegee

PRODUCT DESCRIPTION: 60" ergonomic blue powder coated aluminum handle and heavy duty aluminum frame. Excellent for pushing water through grass and smooth hard surfaces. Widely used on professional sports fields.

Item# SMW-70948

Brooms



General Purpose Broom

PRODUCT DESCRIPTION:
24" general purpose broom with 60" yellow fiberglass handle and cushion grip.

Item# SMW-82724



Monster Drag Broom

PRODUCT DESCRIPTION:
84" monster warehouse drag broom with 3 bristle rows. Bristles are replaceable.

Item# SMW-83084

MAINTENANCE TOOLS & FIELD ACCESSORIES

Aerification Tines

Quad Tines

PRODUCT DESCRIPTION: JRM, Inc. offers a variety of Quad side-eject coring tines that fit all conventional machines. Common mount sizes for Quad blocks are 3/8" and 1/2". The 1/4" standard Quad offers the smallest core available in the industry, and the 1Q625103 pulls one of the biggest cores available on the market.

Conventional Coring Tines – Top Eject

PRODUCT DESCRIPTION: JRM, Inc. offers a full line of conventional coring tines for John Deere®, Toro®, Ryan®, Coremaster®, and Jacobsen® machines. Top-eject tines offer a cleaner and more consistent core.

Deep Tines

PRODUCT DESCRIPTION: JRM, Inc. offers a wide variety of lengths and outside diameters of Deep Coring tines for VERTI-DRAIN®, Soil Reliever®, and Wiedenmann® machines.

Conventional Solid Tines

PRODUCT DESCRIPTION: JRM, Inc.'s conventional solid tines come in a variety of lengths and diameters and feature a bullet-tip, which provide a cleaner hole and consistent core depth.

Bayonet™ Tines

PRODUCT DESCRIPTION: JRM, Inc.'s Bayonet™ tine is a slicing solid tine that comes in lengths of 4 3/4" and 7" and a variety of mount sizes. We also feature longer lengths for deep tines machines. The Bayonets are particularly useful in the summer and in periods of stress when aerification would be problematic.

Crosstines

PRODUCT DESCRIPTION: JRM, Inc.'s CROSSTINE line is a venting tine in times of stress that severs the roots with its unique design and allows for a stronger root mass with little playability concerns when aerating.

SMART TURF TIP

FROM THE SMART TURF BLOG



Aerification Displacement Chart

Tine Size	1.25" x 1.25" Centers	1.5" x 1.5" Centers	2.0" x 2.0" Centers	2.5" x 2.5" Centers	5" x 5" Centers
1/4" Hollow Tines	3.14%	2.18%	1.23%	0.79%	
3/8" Hollow Tines	7.07%	4.91%	2.76%	1.77%	
1/2" Hollow Tines	12.57%	8.73%	4.91%	3.14%	
5/8" Hollow Tines		13.64%	7.67%	4.91%	
5/8" Hollow Vertidrain					1.23%
3/4" Hollow Tines				7.07%	1.77%
3/4" Hollow Vertidrain					1.77%
1" Hollow Tines					3.14%
1" Hollow Vertidrain					3.14%
7/8" Drill & Fill (7" Ctrs)					1.23%
Graden Verticutter (15 Blades @ 1" Spacings)	1mm Blade 3.93%	2mm Blade 7.87%	3mm Blade 11.81%		

1/4" Quadtines remove as much material as Regular 1/2" Hollow Tines.

3/8" minimum for ease of topdressing fill if replacement of material is required for double aerification make two passes at approx. 37° (slightly less than 45°) to minimize overlap.

Source: International Sports Turf Research Center

MAINTENANCE TOOLS & FIELD ACCESSORIES

Drags



Stiff Drag

PRODUCT DESCRIPTION: Heavy duty nonflexible drag used for standard everyday infield maintenance. Can be pulled by hand or with a machine. Wood board bottom, standard size is 6' wide by 18" depth.

SMART TURF TIP

FROM **TURFACE ATHLETICS**



How to Build a Nail Drag

A nail drag is the ideal tool for maintaining a smooth and consistent infield surface.

1. Build with 2" x 4" wood and pre-drill straight holes for nails.
2. Using 40 penny nails, stagger nails 1 3/4" apart - 2 rows in each board.
3. Use a 1" x 4" piece of wood to cover 2" x 4" on top to hold in nails.
4. Screw eye bolts into the corners of the drag so that a chain can be attached to pull the drag.
5. Different sizes can be built to accommodate your infield, baselines, and home plate.

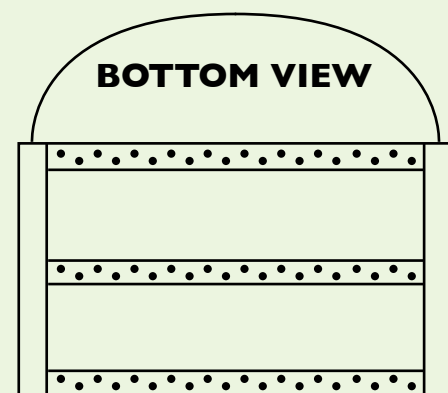
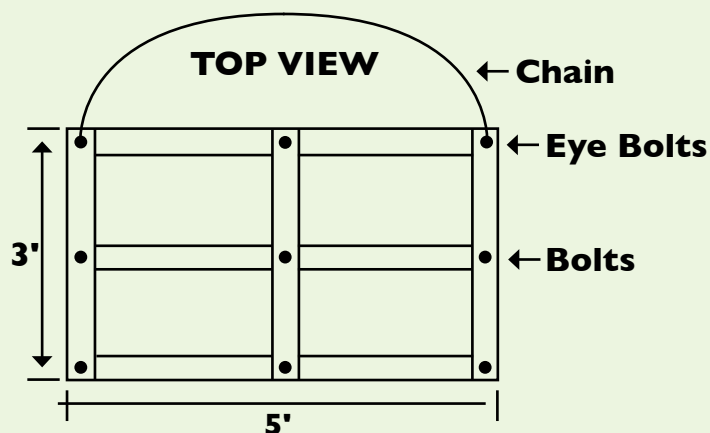

◀ 2 0

◀ 3 0

◀ 4 0

EQUIPMENT

Zero-Turn Sprayer/Spreaders

Steel Green Manufacturing SG36

PRODUCT DESCRIPTION: Experience the versatility of the SG36 zero-turn sprayer-spreader machine. It has all the power of our larger models but is compact enough to fit through a 36-inch gate. With its dual 15-gallon spray tanks, Spyker 125-pound hydraulic-driven granular system, and high-density poly fertilizer trays, the SG36 holds up to 30 gallons of liquid and 225 pounds of granular product. Steel Green machines feature a 21-hp engine, Donaldson air cleaner and a standard integrated 20/50 amp charging system.

SPRAY CAPACITY: 30 gal

SPRAY WIDTH: 2' or 4' or 6' or 8'

HOPPER CAPACITY: 125 lbs

VARIABLE SPRAY WIDTH: up to 25'

FUEL CAPACITY: 5 gal

TRANSPORT SPEED: 10 MPH

RATE PRODUCTION: 120,000 sq ft per fill
based on ¼ gal spray nozzles

WIDTH: 35.5"

LENGTH: 80"

HEIGHT: 54"

FRONT TIRE: 16"

REAR TIRE: 21x7.00-10



Steel Green Manufacturing SG46

PRODUCT DESCRIPTION: Offering versatility without compromising capacity, the SG46 zero-turn sprayer-spreader machine has all the power and spreading capacity of our larger model in a more compact size. With its dual 15-gallon spray tanks, Spyker 225-pound hydraulic-driven granular system, and high-density poly fertilizer trays, the SG46 holds up to 30 gallons of liquid and 325 pounds of granular product. Steel Green machines feature a 21-hp engine, Donaldson air cleaner and a standard integrated 20/50 amp charging system.

SPRAY CAPACITY: 30 gal

SPRAY WIDTH: 2' or 4' or 6' or 8'

HOPPER CAPACITY: 225 lbs

VARIABLE SPRAY WIDTH: up to 25'

FUEL CAPACITY: 5 gal

TRANSPORT SPEED: 12 MPH

RATE PRODUCTION: 120,000 sq ft per fill
based on ¼ gal spray nozzles

WIDTH: 46"

LENGTH: 80"

HEIGHT: 54"

FRONT TIRE: 16"

REAR TIRE: 22x11.00-10



Steel Green Manufacturing SG52

PRODUCT DESCRIPTION: Feel the power and productivity of the SG52 zero-turn sprayer-spreader machine. Dual 30-gallon spray tanks hold up to 60 gallons of liquid, and the Spyker 225-pound hydraulic-driven granular system with high-density poly fertilizer trays can carry up to 325 pounds of granular product. Steel Green machines feature a 21-hp engine, Donaldson air cleaner and a standard integrated 20/50 amp charging system.

SPRAY CAPACITY: 60 gal

SPRAY WIDTH: 2' or 6' or 8' or 10'

HOPPER CAPACITY: 225 lbs

VARIABLE SPRAY WIDTH: up to 25'

FUEL CAPACITY: 5 gal

TRANSPORT SPEED: 12 MPH

RATE PRODUCTION: 240,000 sq ft per fill
based on ¼ gal spray nozzles

WIDTH: 52"

LENGTH: 74"

HEIGHT: 54"

FRONT TIRE: 16"

REAR TIRE: 22x11.00-10



4 0 ▶

3 0 ▶

2 0 ▶

EQUIPMENT

Spreaders

Spyker P70-17520 Drop Spreader



PRODUCT DESCRIPTION:

This commercial drop spreader from Spyker is perfect for spreading seed, fertilizer, and even infield conditioner. With two side-by-side hopper sections, the operator can spread 18" or 36" widths for consistent coverage around tight areas. Comes standard with variable rate and 1/2" fixed rate bottoms. Epoxy powder coated painted welded frame and hopper. 36" spread width, 120 lb. capacity, 13" x 5" pneumatic tires.

The Anderson's SR-2000 Rotary Spreader



PRODUCT DESCRIPTION:

Thicker walled stainless steel frame. Patented Helical Cone for a uniform, consistent 8' - 12' spread swath. 13" Turf Saver 2 pneumatic wheels. Lift handles in the front and back for easier loading and unloading. Standard port shut-off control. Extended handle with tuff-foam grips.

SMART TURF TIP

FROM THE **SMART TURF** BLOG



Calibrating Your Granular Spreader

- To determine the rate of fertilizer per 1,000 sq. ft. based on nitrogen needs, divide the pounds of nitrogen you need by the percent of nitrogen in the formulation to get the pounds of fertilizer you will need per 1,000 sq. ft. **Example: __ lbs. N / __ % N = __ lbs. per 1,000 sq. ft. fertilizing material to apply.**
- You will need an open area at least 50 feet long, a bucket, calculator, tape measure, scale, and fertilizer to be calibrated.
- Estimate the amount of fertilizer you will need for this test and place it in the spreader.
- Set the spreader at the setting suggested on the bag for your spreader. This is a suggested setting only. The condition, age, and model of your spreader will cause differences in the actual settings.
- Spread the material along the open area you have chosen. Walk at the pace you normally walk during actual applications. Many spreaders are dependent on walking speed along with spreader settings. Start your walk before your measured start point to ensure accurate calculations.
- Weigh the amount of material left in the spreader.
- Measure the length and width of the area covered. Calculate this into square feet (length x width).
- Calculate the amount applied per 1,000 sq ft.
Example: __ lbs. x (1,000 sq. ft. / __ sq. ft.) = __ lbs. applied per 1,000 sq. ft.
- Adjust the spreader settings to adjust your rate to spread less material and repeat the test process.
- Factors that affect spreader settings include: walking speed, differences in granular size, moisture content of granulars, coatings, age and condition of spreader, amount of overlap and other similar conditions.



SMART TURF TIP

FROM THE SMART TURF BLOG



"Bluemuda" for #ZeroTransitionTurf

The concept of "Bluemuda" allows turf managers to grow warm and cool season grasses together, year-round and avoid the headaches associated with the transition zone. Improved varieties of bluegrass, like Turf Blue HGT from Barenbrug, germinate and establish faster and have more heat tolerance and disease resistance, which make them attractive for athletic fields. By inter-seeding the Bluegrass into a Bermudagrass field, you eliminate the need to overseed the entire playing surface every fall. And there is no transition, so there is no need for a chemical application to remove your cool season turf from the Bermuda. Other benefits include better wear tolerance, improved playability and better color year round. If you deal with high traffic fields, would like to see a darker green in your Bermudagrass, and deal with the pitfalls of the weather patterns in the transition zone, then Bluemuda might be the solution for you.



Boyle County Schools - Danville, KY
Bluemuda Soccer Field
Megan VanArsdale, Grounds Director
Customer since 2014

GRASS SEED

A proud distributor of Barenbrug, Pure Seed, and Mountain View grass seed, ATS offers premium sports turf varieties designed to withstand heavy traffic while providing superior disease and drought resistance.



Bermudagrass Blends

Jubilee Bermudagrass Blend

PRODUCT DESCRIPTION: 70% Riviera bermudagrass, 30% Transcontinental bermudagrass with seed coating.

PACKAGE SIZES: 20 lb.

SEEDING RATE: 1-2 lbs/1000 sq ft

Riviera

PRODUCT DESCRIPTION: 100% Riviera bermudagrass with seed coating. Riviera is the result of many years of selection for improved turf quality, cold tolerance, superior wear tolerance, seed production, and disease resistance in the transition zone.

PACKAGE SIZES: 25 lb.

SEEDING RATE: 1-2 lbs/1000 sq ft

Ryegrass Blends

Turf Star® with RPR® (70% RPR, 30% PR)

PRODUCT DESCRIPTION: Barenbrug's Regenerating Perennial Ryegrass, or RPR, stands up to heavy traffic while keeping its good looks. While producing a determinate stolon, Turf Star with RPR outperforms traditional perennial ryegrass.

PACKAGE SIZES: 50 lb.

SEEDING RATE: 6-7 lbs/1000 sq ft

Breakout with STT

PRODUCT DESCRIPTION: Smooth Transition Technology (STT) provides quick germination and won't persist into summer. Breakout with STT blends well with other grasses and withstands wear and daily use.

PACKAGE SIZES: 50 lb.

SEEDING RATE: 7.5-15 lbs/1000 sq ft

Sunrye

PRODUCT DESCRIPTION: Sunrye is Pure Seed's GLR selected blend for disease resistant and drought tolerance. Sunrye displays a very dark green color and density at variable mowing heights.

PACKAGE SIZES: 50 lb.

SEEDING RATE: 4-8 lbs/1000 sq ft

Advanced Athletic 50/50 (KB/PR Mix)

PRODUCT DESCRIPTION: Elite varieties of Kentucky Bluegrass and Perennial Ryegrass. Available with Foliar-Pak XCD coating.

PACKAGE SIZES: 50 lb.

SEEDING RATE: 4-5 lbs/1000 sq ft

SMART TURF TIP

FROM THE **SMART TURF** BLOG



For heavy traffic areas, overseed weekly with quality seed.

GRASS SEED

Kentucky Bluegrass Blends

Turf Blue® HGT®

PRODUCT DESCRIPTION: Turf Blue HGT is an easy to grow, fast to establish, and resistant to disease family of blends from Barenbrug. These benefits combined with a remarkable tolerance to heavy traffic make HGT the ideal choice for any bluegrass application.

PACKAGE SIZES: 50 lb.

SEEDING RATE: 2-3 lbs/1000 sq ft

Advanced Elite Bluegrass Blend

PRODUCT DESCRIPTION: Advanced Turf Solutions 100% Elite Kentucky bluegrass selected for its turfgrass quality, fast establishment, and wear tolerance.

PACKAGE SIZES: 50 lb.

SEEDING RATE: 2-3 lbs/1000 sq ft

Advanced 80/20 (80% KB, 20% PR)

PRODUCT DESCRIPTION: Advanced Turf Solutions blend of 80% Elite Kentucky bluegrass and 20% perennial ryegrass varieties.

PACKAGE SIZES: 50 lb.

SEEDING RATE: 3-4 lbs/1000 sq ft

Advanced Athletic 50/50 (KB/PR Mix)

PRODUCT DESCRIPTION: Elite varieties of Kentucky Bluegrass and Perennial Ryegrass. Available with Foliar-Pak XCD coating.

PACKAGE SIZES: 50 lb.

SEEDING RATE: 4-5 lbs/1000 sq ft

Turf Type Tall Fescue Blends

Turf Saver® with RTF® (40% RTF, 60% TTTF)

PRODUCT DESCRIPTION: Turf Saver RTF, developed by Barenbrug, is a unique combination of high quality tall fescue and RTF. Rhizomatous Tall Fescue gives Turf Saver the added value no other tall fescue blends have.

PACKAGE SIZES: 50 lb.

SEEDING RATE: 7-8 lbs/1000 sq ft

Sungold

PRODUCT DESCRIPTION: 100% three-way turf type tall fescue blend developed by Pure Seed for excellent turfgrass quality.

PACKAGE SIZES: 50 lb.

SEEDING RATE: 3-5 lbs/1000 sq ft

Sungold Plus (90% TTTF, 10% KB)

PRODUCT DESCRIPTION: Blend of 90% high quality turf type tall fescue varieties and 10% Kentucky bluegrass developed by Pure Seed.

PACKAGE SIZES: 50 lb.

SEEDING RATE: 2-3 lbs/1000 sq ft

Don't see what you need?
Ask your rep about additional products. Visit advancedturf.com.

FERTILIZER & CHEMICALS

ATS carries a broad line of fertilizers and chemical products from leading manufacturers including the following:

ADVANCED
TURF SOLUTIONS

Foliar-Pak

ArmorTech

The Andersons

BASF



PRECISION
LABORATORIES

EC GROW

FMC

healthy
grow

Dow

Nufarm

G pbi/gordon
CORPORATION

Lebanonturf

Granular Fertilizer

Healthy Grow® enhanced with Armament®

PRODUCT DESCRIPTION: Contains Aerobically Composted Chicken Manure (ACCM) infused with a biological meta-catalyst that promotes beneficial microbial activity in and around the soil and plants. It's an all-natural, slow-release, organic-based blend that provides a rich soil environment for strong, healthy plants that are less susceptible to environmental and disease pressures. Available in the following analyses: 2-4-8, 8-3-5, and 10-3-2.

ATS Professional Turf Fertilizers with Armament®

PRODUCT DESCRIPTION: Using spray-on technology, each fertilizer granule is completely coated with boron, zinc, and Foliar-Pak's Armament technology—creating an opportunity for better nutrient uptake in the turf through better rooting and increased nutrient availability. Available in a variety of N-P-K analyses and with slow release technology.

Foliar & Soluble Fertilizer

Foliar-Pak® Grow-In

PRODUCT DESCRIPTION: Combines the liquid nutrients required for rapid turfgrass establishment and recovery—including comprehensive nutrition, amino acids, that provides other beneficial components, and a biological package—while offering the convenience of one single product. Foliar-Pak Grow-In expedites maturity, density, and hardness of the turfgrass stand. Protected by Armament technology.

Foliar-Pak® Play On

PRODUCT DESCRIPTION: Contains essential foliar nutrition, amino acids, beneficial bacteria, and Armament technology for a comprehensive solution to in-season maintenance. Foliar-Pak Play On provides the benefits of a complete sports field maintenance program with the convenience of one single product. Or build your own program using Foliar-Pak's line of premium liquid nutrients

SMART TURF TIP

FROM THE SMART TURF BLOG



The Ultimate Sports Turf Package

From seeding and establishment to maintenance and recovery, our Ultimate Sports Turf Package offers comprehensive programs designed to take the guess work out of turf management. The warm season and cool season establishment programs incorporate Foliar-Pak, Healthy Grow and Armament technologies to expedite turf establishment and promotes better density, rooting and turfgrass strength, advancing seedlings or sprigs from infancy to maturity faster than ever before. The maintenance programs maximize turf health, increase stress tolerance, and prepare athletic turf for high traffic events. Ask your sales rep for the program details, or find them on the Smart Turf blog at janddturf.blogspot.com.

FERTILIZER & CHEMICALS

Insecticides

ArmorTech® IMD 75 & IMD 2SC

PRODUCT DESCRIPTION: A broad-spectrum insecticide offering foliar and systemic insect control in turfgrass. IMD 75 contains 75% imidacloprid in a dry formulation. IMD 2SC contains 21.4% imidacloprid in a flowable formulation.

Talstar® Professional

PRODUCT DESCRIPTION: Long-lasting control of over 75 pests, including ants, termites, cockroaches, spiders, bed bugs, fleas and ticks. Talstar Professional is water based, so it's non-irritating and contains no odorous or plant-damaging solvents. Talstar Professional leaves no unsightly residues and causes no phytotoxicity. Contains bifenthrin.

Plant Growth Regulators

ArmorTech® PGR 113

PRODUCT DESCRIPTION: A water-based microemulsion concentrate used to manage growth and improve quality and stress tolerance of warm and cool season turfgrasses. Contains 11.3% trinexapac-ethyl.

ArmorTech® PAC 223

PRODUCT DESCRIPTION: A systemic plant growth regulator that slows vegetative growth by inhibiting gibberellin biosynthesis. Improves overall quality of turfgrass, slows grass growth mowings and clippings for up to 2 months. Contains 22.3% paclobutrazol.

Wetting Agents

Hydro-Pak® Command

PRODUCT DESCRIPTION: Reduce soil surface tension, allowing water and nutrients to reach the root zone with this organic acid penetrant. Command is ideal for irrigation injection and is a cost-effective choice for turfgrass on sports fields.

Vivax®

PRODUCT DESCRIPTION: A combination of new surfactant technologies designed to manage water across a wide range of soil and turf types, making it ideal for use on sports turf. Available in liquid, granular, and tablet formulation.

Hydro-Pak® BioWet

PRODUCT DESCRIPTION: BioWet is a multi-functional, biodegradable wetting agent that works with the soil ecology while bringing a high level of performance. By working to improve the moisture balance in the root zone through a combination of biodegradable penetration and hydration agents, BioWet improves oxygen levels, microbial levels, and plant stress tolerance.

Don't see what you need?
Ask your rep about additional products. Visit advancedturf.com.

FERTILIZER & CHEMICALS

Fungicides

ArmorTech® TMI 2020 XL

PRODUCT DESCRIPTION: Two active ingredients provide contact and systemic action for quick, lasting protection against dollar spot, leaf spot, pink snow mold, and other fungal diseases. Contains 19.65% thiophanate-methyl and 19.65% iprodione.

ArmorTech® CLT 720

PRODUCT DESCRIPTION: Provides curative and preventative disease protection against major turf diseases. Contact mode of action allows quick results while a multi-site mode of action prevents disease resistance. Contains 54% chlorothalonil.

ArmorTech® ZOXY-PG®

PRODUCT DESCRIPTION: A granular fungicide combining 0.31% Azoxystrobin and 0.75% Propiconazole. A broad spectrum fungicide, it utilizes both root and leaf uptake to deliver preventative and curative control up to 28 days.

Xzemplar®

PRODUCT DESCRIPTION: Provides quick-acting and long lasting control of a broad spectrum of diseases including dollar spot, brown patch, snow mold, and more. Contains 26.55% fluxapyroxad, which is an SDHI or succinate-dehydrogenase inhibitor, Group 7 fungicide.

Herbicides

Dimension® Specialty Herbicide

PRODUCT DESCRIPTION: Offers pre-emergence and early postemergence crabgrass control plus pre-emergence control of 47 other grassy and broadleaf weeds.

Millennium® Ultra 2

PRODUCT DESCRIPTION: Premium post-emergence herbicide for control of the most challenging broadleaf weeds. This unique formulation translocates to the roots and even effective on deep-rooted perennials such as thistle, goldenrod, artichoke, and nettle. Contains 37.32% 2,4-D, 2.54% clopyralid, and 4.65% dicamba.

Speedzone®

PRODUCT DESCRIPTION: With four powerful active ingredients, SpeedZone Broadleaf Herbicide for Turf provides fast, dependable control of tough broadleaf weeds, including clover, plantain, ground ivy, and spurge. Contains .62% carfentrazone-ethyl, 28.57% 2,4-D, 5.88% mecoprop-p acid, and 1.71% dicamba acid.

SureGuard® & BroadStar®

PRODUCT DESCRIPTION: Active ingredient flumioxazin controls a broad spectrum of annual broadleaf and grassy weeds, making it the perfect pre-emergent herbicide to treat warning track and infields. SureGuard contains 51% flumioxazin in a water dispersible granule for spray application. BroadStar contains .25% flumioxazin in a low odor, dust-free granule formulation.



2 0

3 0

4 0

FERTILIZER & CHEMICALS

Spray Tank Additives

Foliar-Pak® Armament® Concentrate

PRODUCT DESCRIPTION: This patented, biodegradable nutrient enhancer keeps nutrients in suspension, preventing interactions in the spray tank and improving nutrient availability. Apply Foliar-Pak Armament Concentrate with routine fertilizer applications for deeper, stronger roots, more resilient turf, and longer-lasting color.

Foliar-Pak® Microsync

PRODUCT DESCRIPTION: Foliar-Pak Microsync is a well-balanced micronutrient package built with amino acids to enhance health, color, and stress tolerance in any turfgrass species. It is the ideal micronutrient addition for lawn care applications and is safe in spray tanks with broadleaf herbicides.

Foliar-Pak® BioDrive

PRODUCT DESCRIPTION: A soil amendment with a highly active humic acid source. BioDrive relieves compaction by reducing flocculation of clay particles that tie up sodium, thus improving overall soil structure, root penetration, oxygen availability, and water availability. It also naturally complexes and chelates nutrients to make them more available for root uptake.

Chem-Stik LPH

PRODUCT DESCRIPTION: A unique non-ionic spreader-sticker formulated to protect pesticides from premature chemical breakdown by buffering the spray solution to a slightly acidic pH level of 5.0 to 6.0.

SMART TURF TIP

FROM PRECISION LABORATORIES



"Adjuvants help improve spray coverage, reduce drift, buffer pH, and increase uptake of products are used with. Choosing the correct product will maximize your application effectiveness."

—Chip Houmes



Parkview Field - Fort Wayne, IN
Keith Winter, Head Groundskeeper
TinCaps Grounds Crew
5-Year Winner Midwest League
Sports Turf Manager/Grounds
Crew of the Year award
Customer since 2010

SERVICE

Why J&D TURF?

J&D Turf is the Midwest's only full-service sports turf product distribution, construction, consultation, and maintenance company. Uniquely positioned to service the sports turf market, J&D Turf partners practical know-how with outstanding customer service to deliver maximum value. J&D Turf has practical, hands-on experience growing and maintaining athletic fields. No matter what field, turf, or soil problem, the team has not only seen it firsthand, they've overcome it using their "Smart Turf" approach.

J&D Turf believes that the potential in every field is realized by understanding the science that drives healthy turf, what they call "Smart Turf." Translating that know-how to projects is what the company's consulting services are all about. Some clients have the manpower to work athletic fields but need direction on what will produce the greatest impact. Other clients, such as architecture and civil engineering firms, need assistance approaching athletic fields in a manner different from the common greenspace. J&D Turf's consulting services range from one-time site visits by the experienced crew to lengthy consulting engagements with Jamie Mehringer.

Consulting

- Facility Maintenance
- Facility Budget Planning
- Project Design and Planning
- Athletic Field Master Planning
- Specification Writing
- Project Management
- Fertilizer Programs
- Soil Testing and Analysis
- Infield Mix Testing and Analysis
- Clegg Field Testing

Maintenance

- Turf Establishment (from seed or sod)
- Custom Chemical and Fertilizer Applications
- Field Grading
- Drainage and Irrigation
- Topdressing
- Aerification
- Overseeding
- Field Edging and Realignment
- Pre and Post Season Cleanup
- Frazee Mowing



Construction

- Laser Grading
- Seeding
- Aerification
- Topdressing
- Warm Season (Bermuda) Turf Establishment
- Cool Season (Bluegrass/Ryegrass) Turf Establishment
- Finish Grading
- Irrigation Installation
- Irrigation Monitoring and Maintenance
- Baseball and Softball Infield Installation and Renovation
- Mound & Plate Construction and Renovation
- Protective Netting

Spend enough time in and around athletic fields in the Midwest and you will see the results of J&D Turf's work and experience.

SERVICE

SMART TURF TIP

FROM THE **SMART TURF** BLOG



Fraze Mowing

Fraze mowing involves the mechanical removal of the top layer of thatch and organic matter that has built up on a natural grass field.

The benefits of fraze mowing include:

- Cleans out thatch and organic build-up that causes the field surface to become hard while making playability slick
- Removes overseeded ryegrass and weed seeds
- Creates stronger turf that requires fewer inputs and maintenance throughout the season
- Smooths out the surface of the field
- Stimulates growth and new shoots from the cut stolons on bermudagrass
- Provides a clean surface to seed into
- Removes build up or lips in the turf along the skinned infield



SERVICE

- A: Pitching Distance F: Home Diameter K: Min. CF Fence Distance
- B: Baseline G: Base Radius L: Batter Box
- C: Plate to 2nd Base H: Coaches Box Distance M: Mound Height
- D: Infield Radius I: Coaches Box
- E: Mound Diameter J: Min. Fence Distance

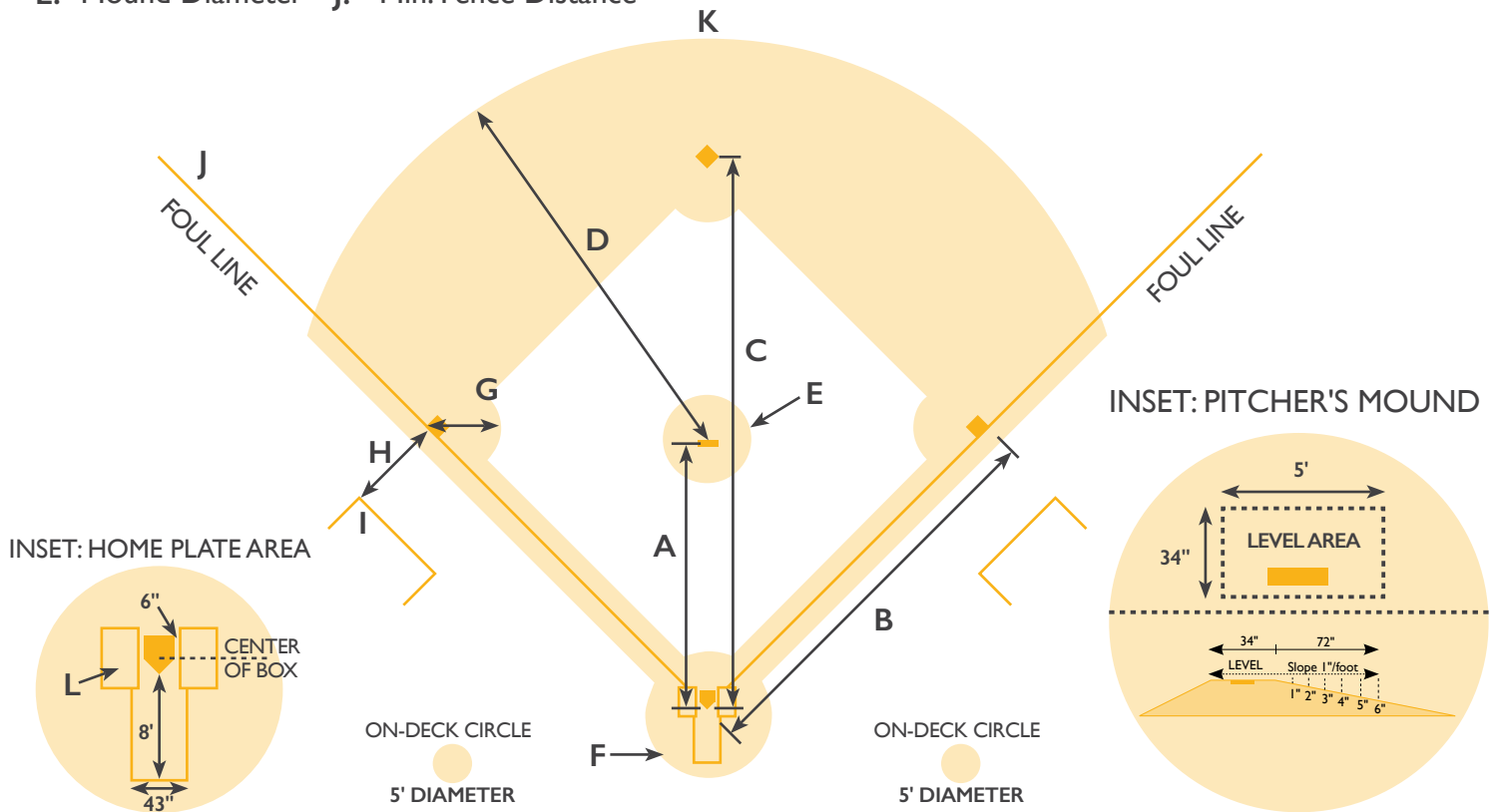

LEAGUE	A	B	C	D	E	F	G	H	I	J	K	L	M
PRO, COLLEGE, HS	60'6"	90'	127' 3 ³ / ₈ "	95'	18'	26'	13'	15'	20'x10'	320'+	400'+	4'x6'	10"
BABE RUTH	60'6"	90'	127' 3 ³ / ₈ "	95'	18'	26'	13'	15'	20'x10'	320'	400'	4'x6'	10"
COLT	60'6"	90'	127' 3 ³ / ₈ "	95'	18'	26'	13'	15'	20'x10'	300'	350'	4'x6'	10"
PONY	54'	80'	113' 1 ² / ₃ "	80'	15'	24'	12'	12'	12'x6'	250'	300'	4'x6'	8"
BRONCO	48'	70'	99'	65'	12'	22'	11'	9'	12'x6'	225'	275'	4'x6'	6"
LITTLE LEAGUE	46'	60'	84' 10 ¹ / ₄ "	50'	10'	20'	9'	6'	8'x4'	200'	200'	4'x6'	6"
MUSTANG	44'	60'	84' 10 ¹ / ₄ "	50'	9'	20'	10'	6'	8'x4'	175'	225'	3'x6'	4"
PINTO	38'	50'	70' 8 ¹ / ₂ "	50'	9'	20'	9'	6'	8'x4'	150'	200'	4'x6'	4"

RESOURCES & DIMENSIONS

High School

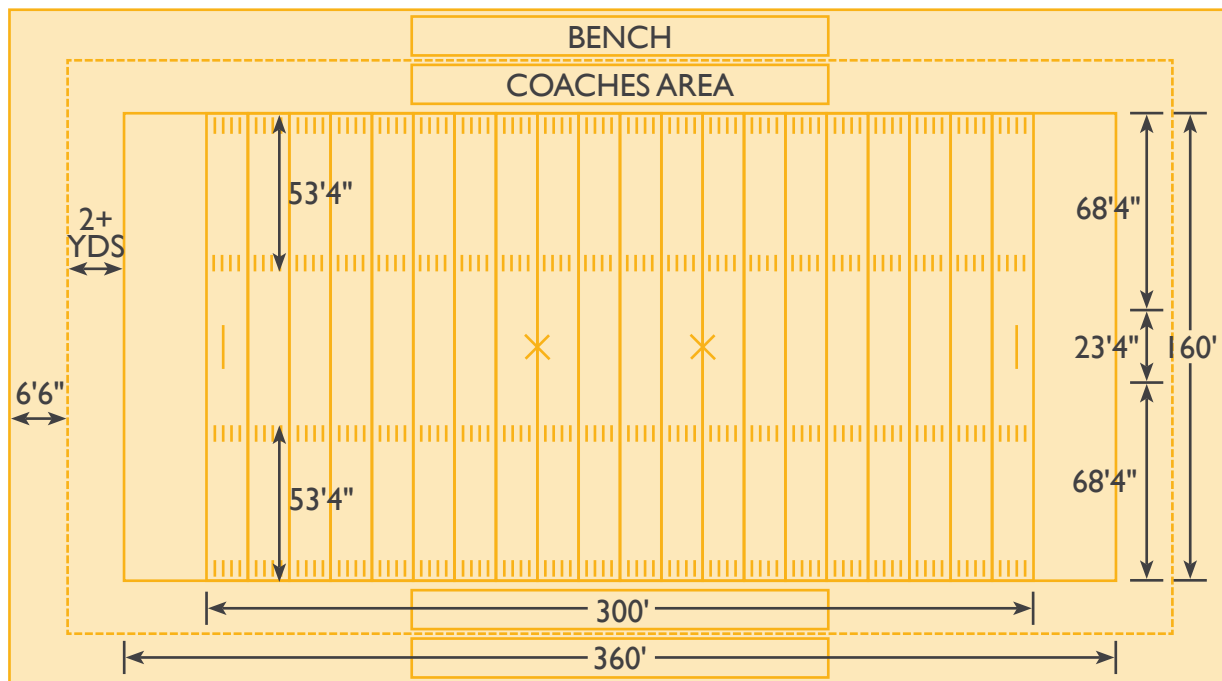

College

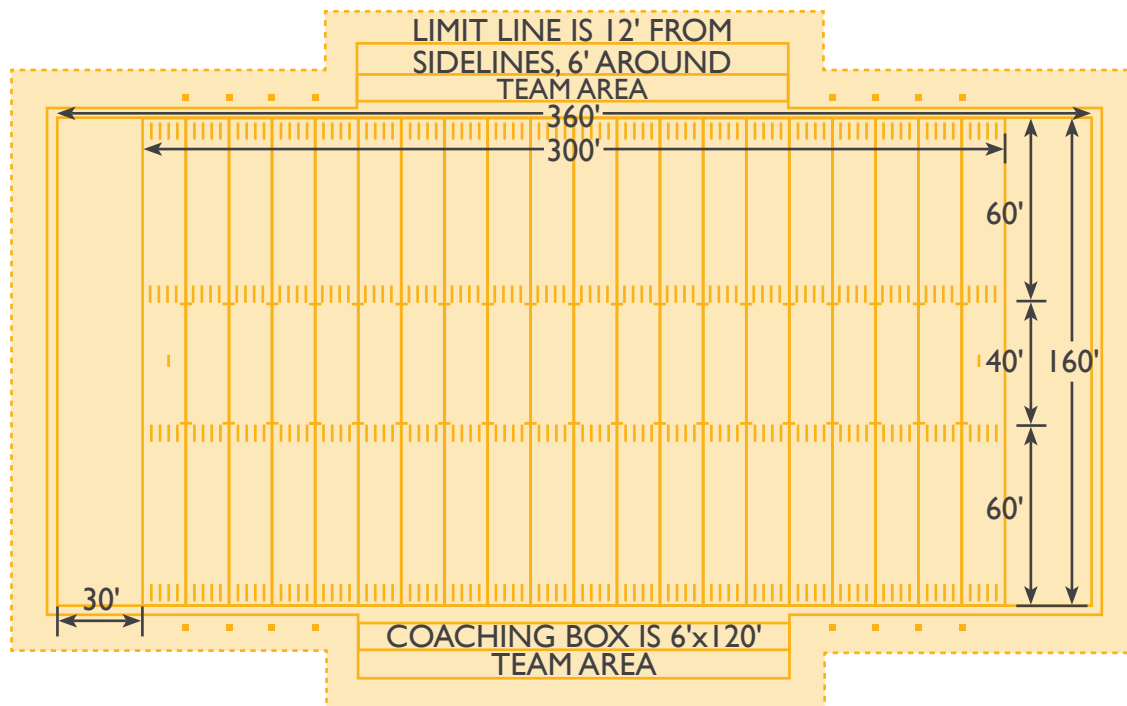

RESOURCES & DIMENSIONS

- A: Pitching Distance
- B: Baseline
- C: Plate to 2nd Base
- D: Infield Arc Radius
- E: Mound Diameter
- F: Coaches Box Distance
- G: Coaches Box
- H: Min. CF Fence Distance
- I: Batter Box

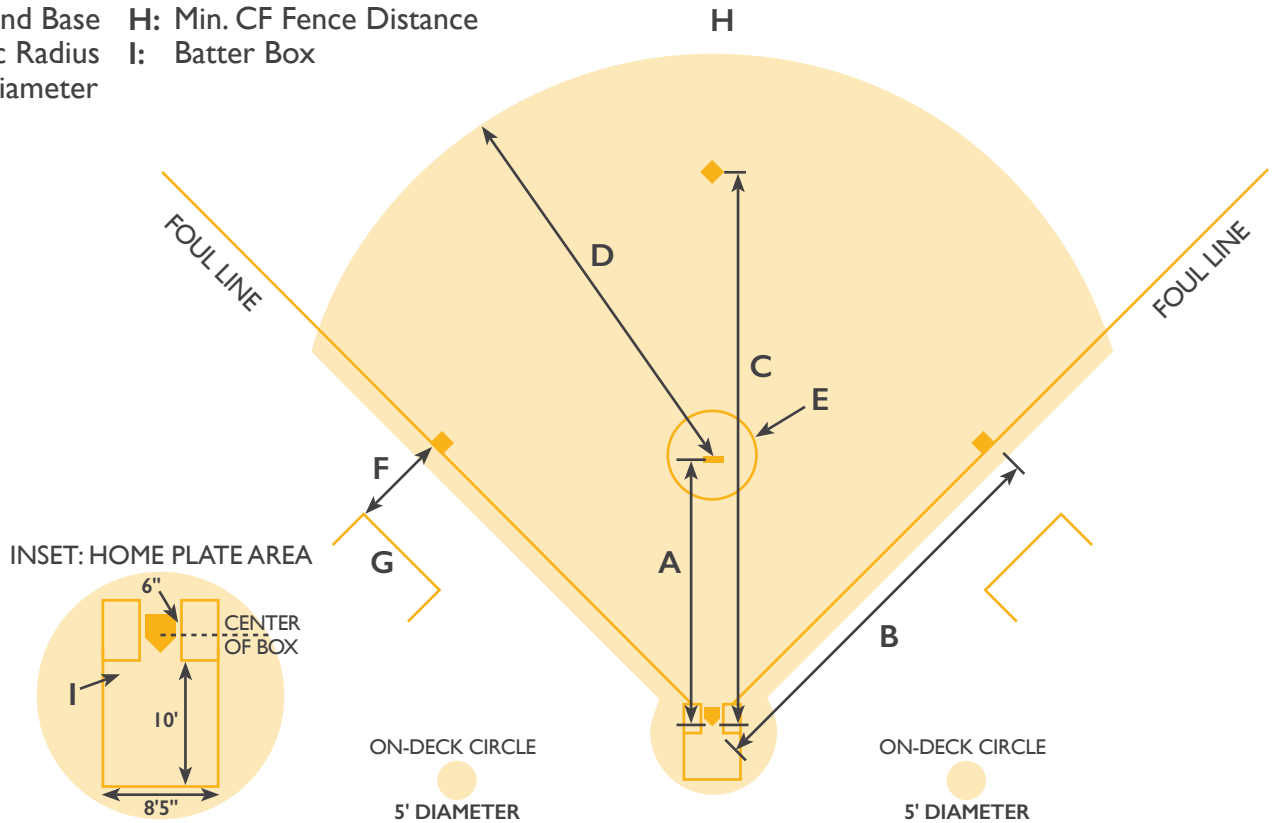

LEAGUE	A	B	C	D	E	F	G	H	I
COLLEGE	43'	60'	84' 10 ¹ / ₄ "	60'	16'	8'	15'x3'	200'	3'x7'
HIGH SCHOOL	40'	60'	84' 10 ¹ / ₄ "	60'	16'	8'	15'x3'	185'-235'	3'x7'
ASA ADULT FASTPITCH / WOMEN	43'	60'	84' 10 ¹ / ₄ "	60'	16'	8'	15'x3'	200'-250'	3'x7'
ASA ADULT FASTPITCH / MEN	46'	60'	84' 10 ¹ / ₄ "	60'	16'	8'	15'x3'	225'-250'	3'x7'
ASA ADULT SLOWPITCH / ALL	50'	65'	91' 11"	65'	NA	8'	15'x3'	275'-300'	3'x7'
ASA YOUTH GIRLS / 10U	35'	55'	77' 9 ³ / ₈ "	60'	16'	8'	15'x3'	175'-225'	3'x7'
ASA YOUTH GIRLS / 12U	40'	60'	84' 10 ¹ / ₄ "	60'	16'	8'	15'x3'	200'-225'	3'x7'
ASA YOUTH GIRLS / 14U	40'	60'	84' 10 ¹ / ₄ "	60'	16'	8'	15'x3'	200'-225'	3'x7'
ASA YOUTH GIRLS / 16U & 18U	40'	60'	84' 10 ¹ / ₄ "	55'	16'	8'	15'x3'	200'-225'	3'x7'

RESOURCES & DIMENSIONS

Mens Lacrosse

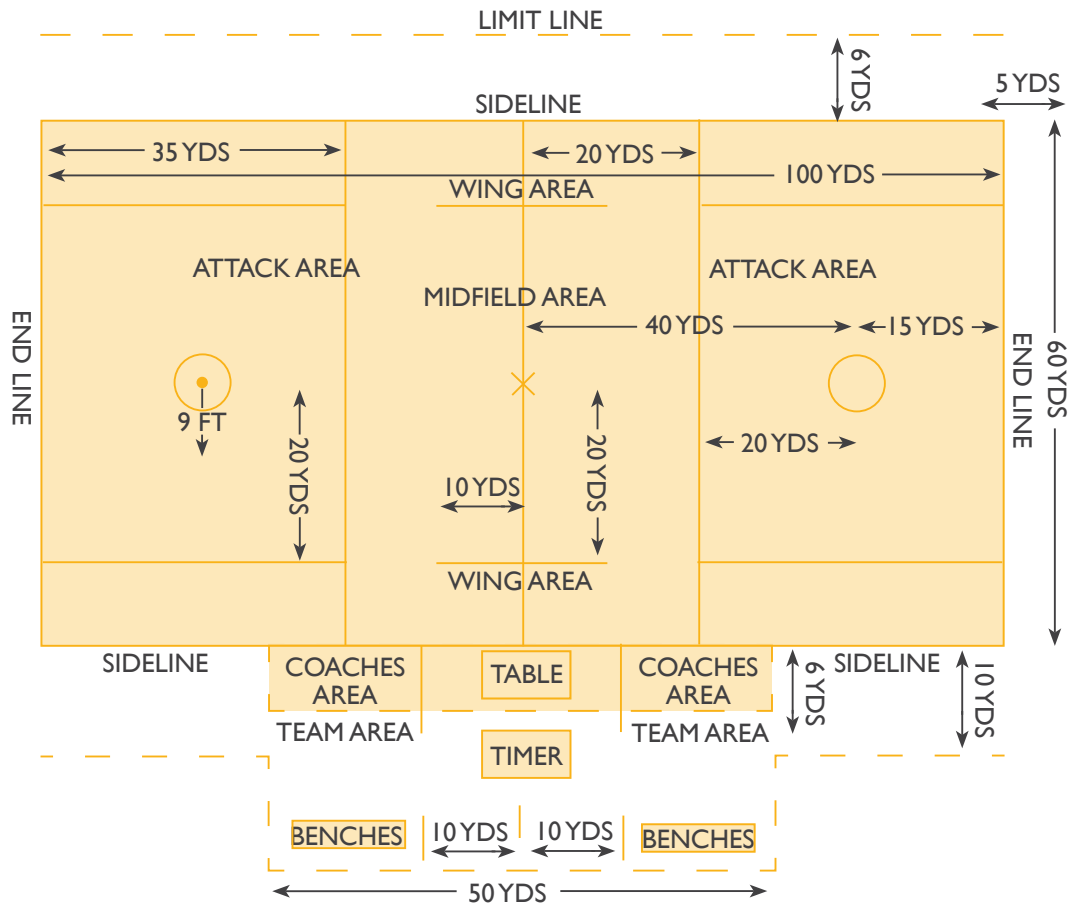

Womens Lacrosse

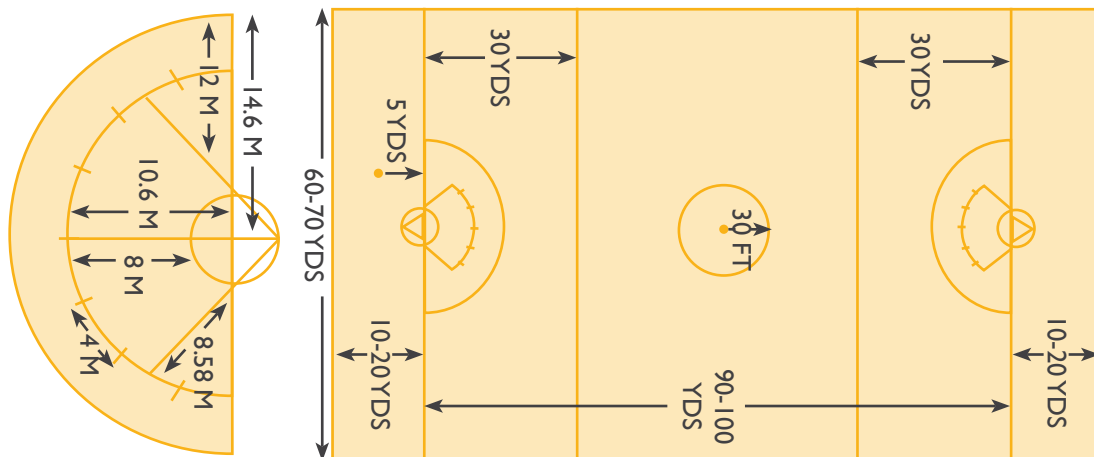

RESOURCES & DIMENSIONS

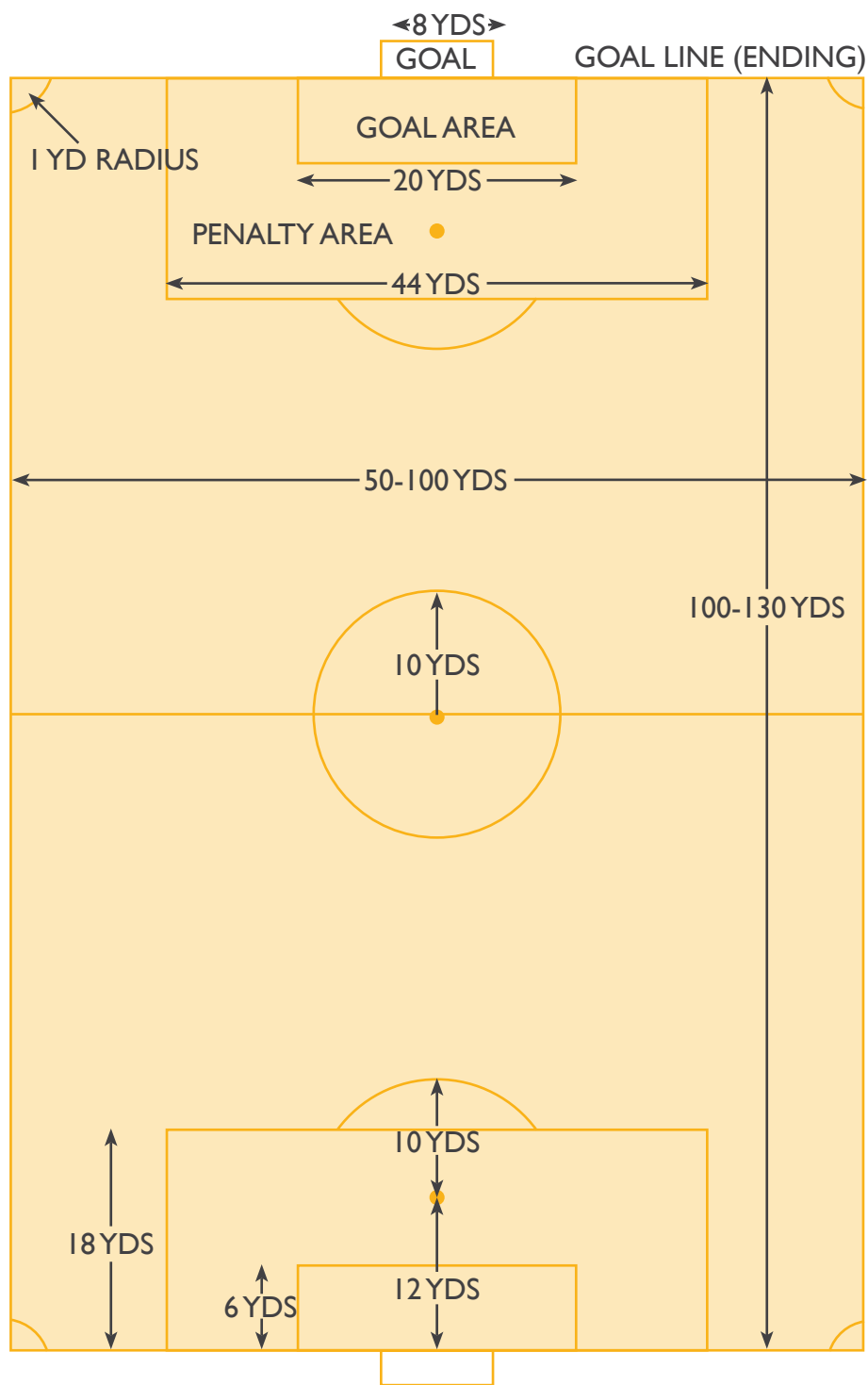

RESOURCES & DIMENSIONS

Rugby

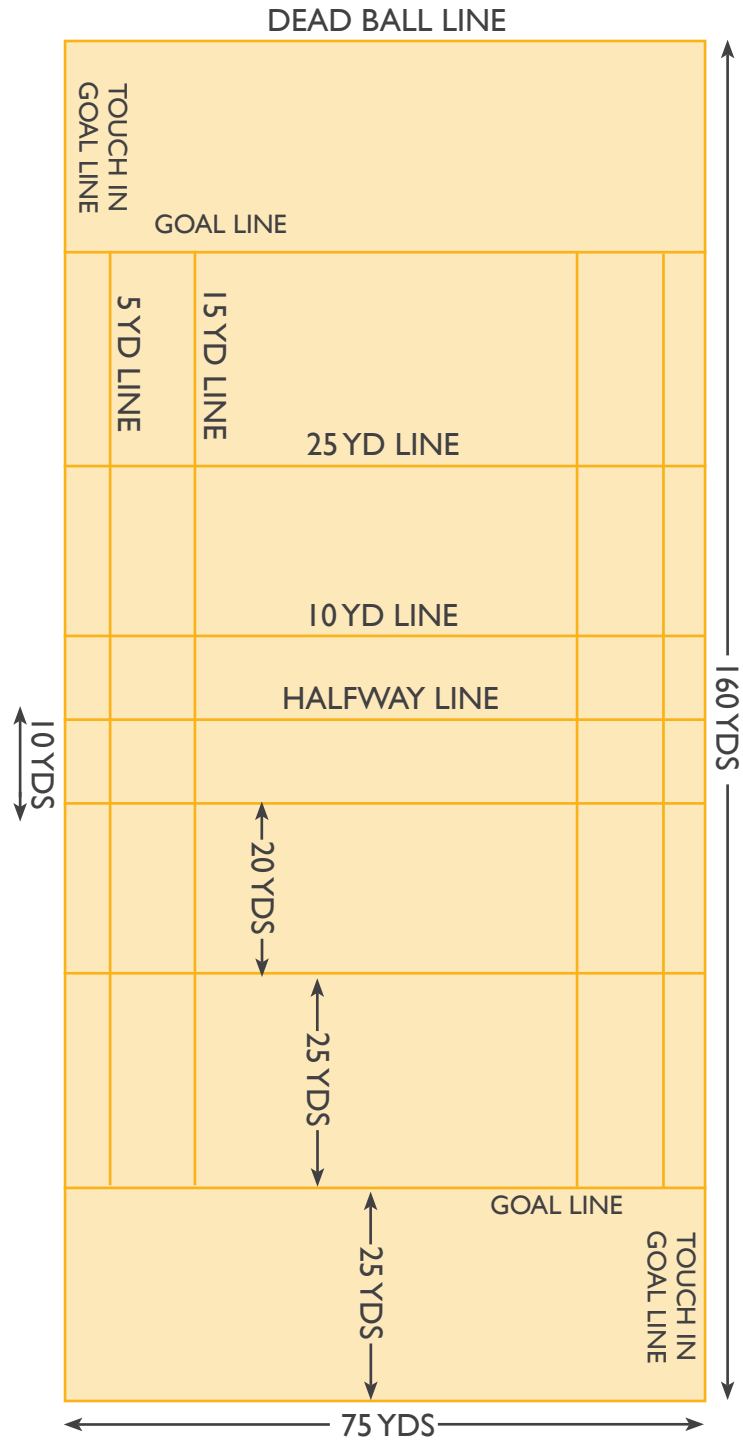

ADVANCED TURF SOLUTIONS®

Indiana

Corporate Office

Central Indiana
12955 Ford Drive
Fishers, IN 46038
877.433.7037

Northern Indiana
3418 CR 6 E
Unit 2
Elkhart, IN 46514
574.264.4500

Kentucky

Cincinnati Area
8975 Empire Connector Drive
Florence, KY 41042
859.283.1172

Louisville Area
2360 Ampere Drive
Louisville, KY 40299
888.781.9453

Michigan

Grand Ledge
3652 Jefferson Highway
Grand Ledge, MI 48837
517.445.5001

Traverse City
4123 Vance Road
Traverse City, MI 49685
231.943.8343

Ohio

Central Ohio
4660 Journal Street
Columbus, OH 43204
866.998.8873

Northern Columbus
9012 Cotter Street
Lewis Center, OH 43035
740.201.1018

Cleveland Area
6780 Southpointe Parkway
Brecksville, OH 44141
440.740.0303

Northeast Ohio
603 N Meridian Road
Youngstown, OH 44509
330.793.3775

Sharonville
12078 Champion Way
Sharonville, OH 45241
513.725.3738

Illinois

Plainfield
24317 W 143rd Street
Unit 103
Plainfield, IL 60544
815.556.1370

Elk Grove Village
1225 Lunt Avenue
Elk Grove Village, IL 60007
847.258.5904

Missouri

St Louis Area
8 Cermak Boulevard
St Peters, MO 63376
314.993.6700

Cape Girardeau
2820 Wintergreen Drive
Cape Girardeau, MO 63701
573.803.2900

Columbia
4205 I-70 Drive Southeast
Columbia, MO 65201
573.350.1075

Pennsylvania

Pittsburgh Area
600 Seco Road
Monroeville, PA 15146
412.376.9097

Wisconsin

Madison, WI
2556 Advance Road, Unit C
Madison, WI 53718
608.709.1331

Tennessee

Nashville Area
604 Airpark Center Drive
Nashville, TN 37217
615.724.6045

J&D TURF

Indiana

Corporate Office

Central Indiana
12955 Ford Drive
Fishers, IN 46038
317.359.1185

Missouri

St Louis Area
8 Cermak Blvd
St Peters, MO 63376
314.993.6700

Wisconsin

Milwaukee, WI
317.359.1185

Online

advancedturf.com
j-dturf.com
janddturf.blogspot.com

🐦 ATSSportsTurf
🐦 AdvancedTurf
🐦 @J_DTurf

